

Operating Instructions

for

S U P E R
T E C H N I K A

6x9 cm

2¹/₄ x 3¹/₄"



Linhof

P R Ä Z I S I O N S - K A M E R A - W E R K E M Ü N C H E N 25

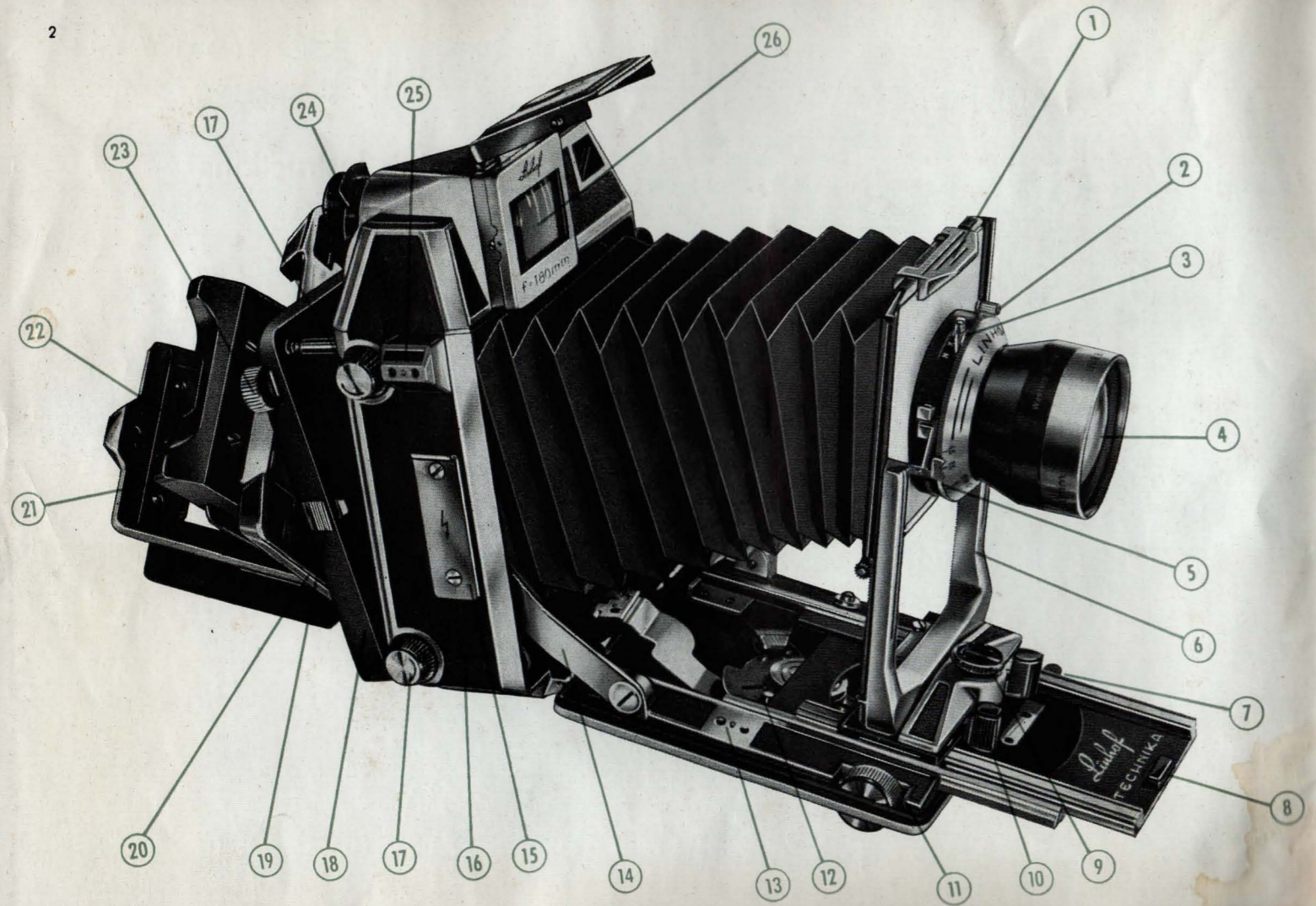

- 1 Lock bar for lens board
- 2 Shutter cocking lever
- 3 Contact nipple for flash cable
- 4 Lens in Compur shutter (fully synchronized)
- 5 Lens diaphragm setting lever
- 6 Lens standard. Extra sturdy design for heavy high-speed and long-focus lenses
- 7 Upper track lock
- 8 Upper track
- 9 Lens standard tilting knob
- 10 Spring-tensioned pull-out grips; when released, lock lens standard at any track position
- 11 Rack-and-pinion focusing knob for triple extension track
- 12 Tri-cam disk, interchangeable, couples three lenses to multifocus rangefinder and distance scale automatically*)
- 13 Cable release socket*)
- 14 Spring-tensioned bed struts to hold bed in normal or dropped position

*) Not provided on Technika 2 1/4 x 3 1/4 without Multifocus Rangefinder.

We reserve the right to make changes in the construction, design, or finish of our products, consistent with the newest developments.

- 15 Flash gun bracket
- 16 Camera body corrosion-proof light-metal die casting, chromium plated
- 17 Lock knob for swing back
- 18 Swinging and tilting back
- 19 Automatic spring lock for swing back
- 20 Revolving quick-change back; detachable
- 21 Ground glass spring back
- 22 Hinged focusing hood frame
- 23 Locking lever for interchange of camera back
- 24 Adjustable finder eyepiece with parallax correction from infinity to 3 feet*)
- 25 Eyelet for neck strap with cable release socket (body shutter release)
- 26 Combination Multifocus Range-and-Viewfinder; viewfinder adjustable for wide-angle (53 or 65 mm.), normal (90 to 105 mm.), telephoto (180 mm., 240 mm.)*)

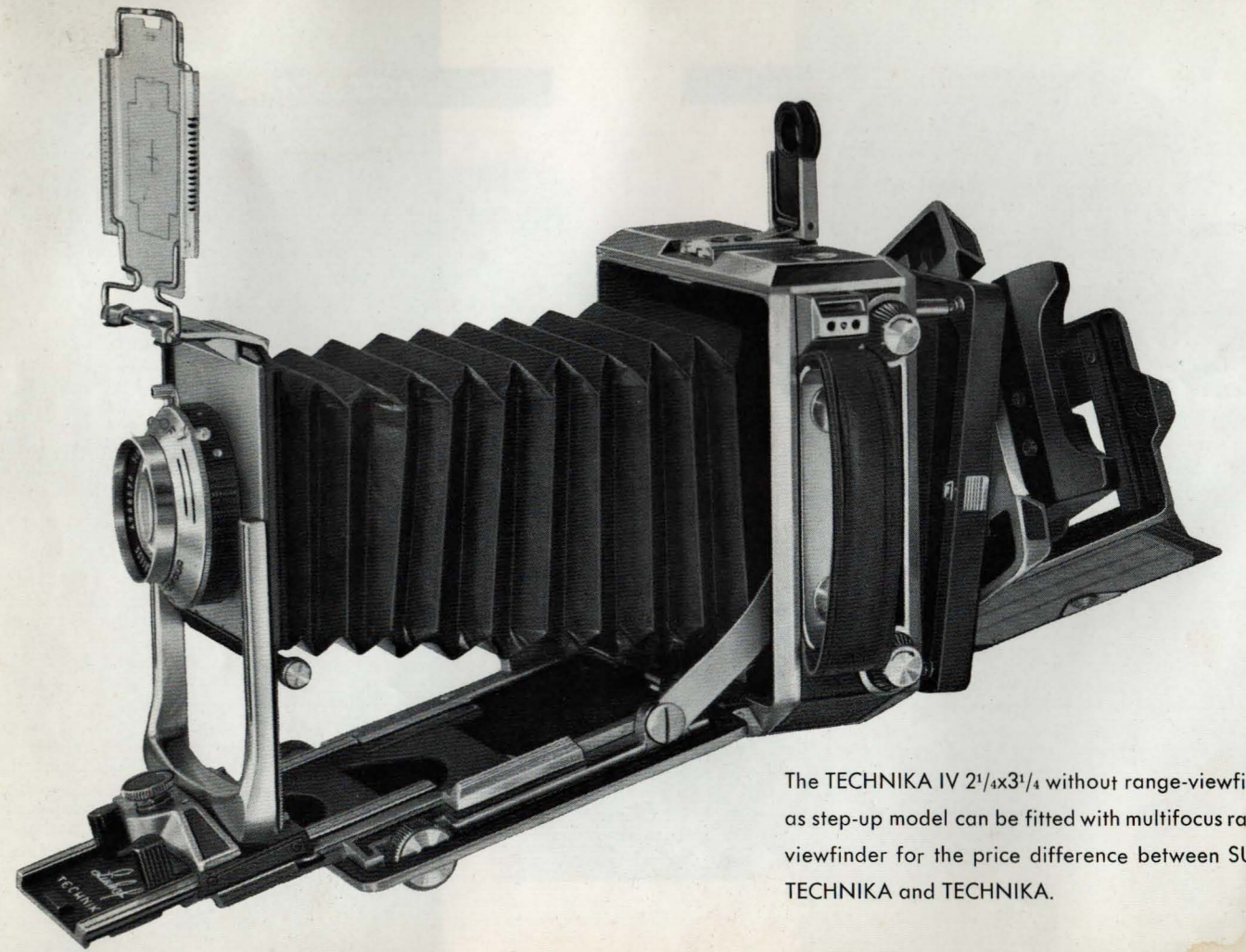

The TECHNIKA IV 2 1/4 x 3 1/4 without range-viewfinder as step-up model can be fitted with multifocus range-viewfinder for the price difference between SUPER TECHNIKA and TECHNIKA.

WORKING WITH FILM HOLDERS

When individual exposures require immediate processing, the LINHOF double holder loaded with film or plates is the perfect answer. (Standard $2\frac{1}{2} \times 3\frac{1}{4}$ holders, film pack adapters, are equally suitable.) The Multifocus range and viewfinder assures speedy camera operation. Just two steps make the camera ready for exposure:

1. Cock the shutter;
2. Insert holder and withdraw dark slide in one motion (illustration 1 and 2).

CAUTION: Be sure shutter is closed when inserting holder.

The Synchro Compur MX 0 shutter permits groundglass focusing even after the shutter speed has been set and cocked. To open the shutter, push back the "press focus button" on top of the shutter housing and release the shutter; the shutter remains open until the button is pulled forward. - Similarly, the Synchro Compur MX 1 shutter has a press focus lever. With the shutter set at speeds from 1 second to $\frac{1}{4000}$ th sec., and cocked, the press focus lever can be pressed down to open the shutter and, after focusing, lifted up to close the shutter, ready for immediate release. The No. 1 shutter also has a delayed-action release (selftimer) button (cannot be used with $\frac{1}{4000}$ sec.); After the shutter has been cocked, push back the selftimer button and pull shutter cocking lever another short distance to a stop. After the shutter release is pressed, about 8 seconds elapse before the shutter operates.



1

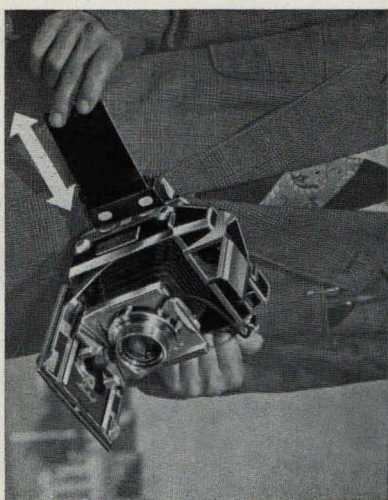

2

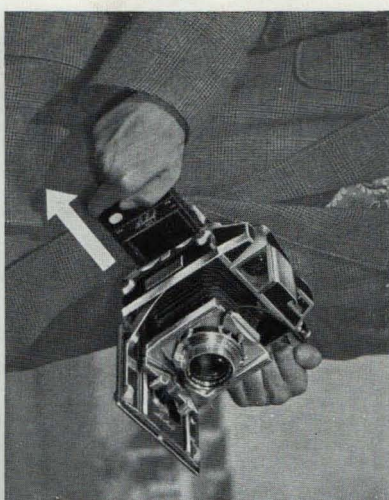

3

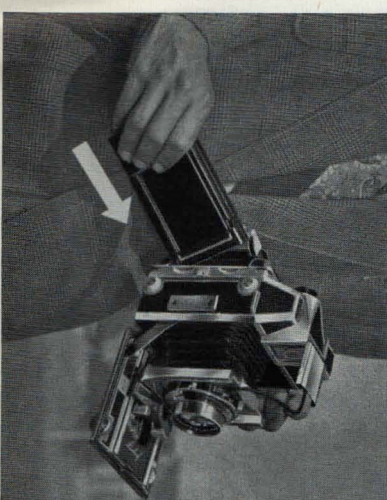

4

After exposure, re-insert dark slide. To withdraw holder from camera, pull backward (to release holder from light lock) and out. (See illustration 3.) Reserve holder and insert for next exposure. (See illustration 4.) The tabs of the dark slides on Linhof holders are numbered. Numbers of unexposed negative material should face OUT; when re-inserting the dark slide after exposure, face the numbers IN. This will tell you at a glance that film has been exposed, and prevents errors. In addition each hinged end of the LINHOF double holder features a built-in numbering tab which corresponds to the number on the dark slide. During the exposure the number is automatically printed on the negative. This helps considerably in identifying negatives after development. By using double holders, it is possible to adapt the best possible type of film or plate to each photographic situation. Thus, panchromatic, infra-red, and color emulsions can be used in succession, if desired.

ACCESSORIES

The Sports Case

has proved its practical value in everyday photography. Despite its small dimensions of 12x7x9 in. and its light weight of approximately 4 lbs. it holds the SUPER TECHNIKA or TECHNIKA 2 1/4 x 3 1/4" with or without Rollfilm Back attached as well as Anatomical Hand Grip, a second Rollfilm Back, the Groundglass Back, two to three accessory lenses, a Compendium Lenshood, and a number of filters. The case is solidly built of medium tan cowhide, which guarantees a long life. The velvet lined separations are adjustable so that the case can be used for different 2 1/4 x 3 1/4" SUPER TECHNIKA outfits. The shoulder strap furnished with an anti-slip pad.

The new 47 mm f/8 Technika Super-Angulon

is an extreme wide angle lens with an angle of approximately 100°, especially suited for architectural and interior photography, further for panorama landscapes. With its help an effect will be obtained never before possible in any 2 1/4 x 3 1/4" camera.

The 47 mm f/8 Super-Angulon is supplied in a helical gear focussing mount on a 2 1/4 x 3 1/4" lensboard which is inserted into the lens standard like a regular lensboard. The lens standard, however, remains on the body track whereas the drop bed is inclined 15° (to the second notch of the bed struts). Focussing is carried out by turning of the helical gear with groundglass observation or with the distance scale engraved on the lens mount.

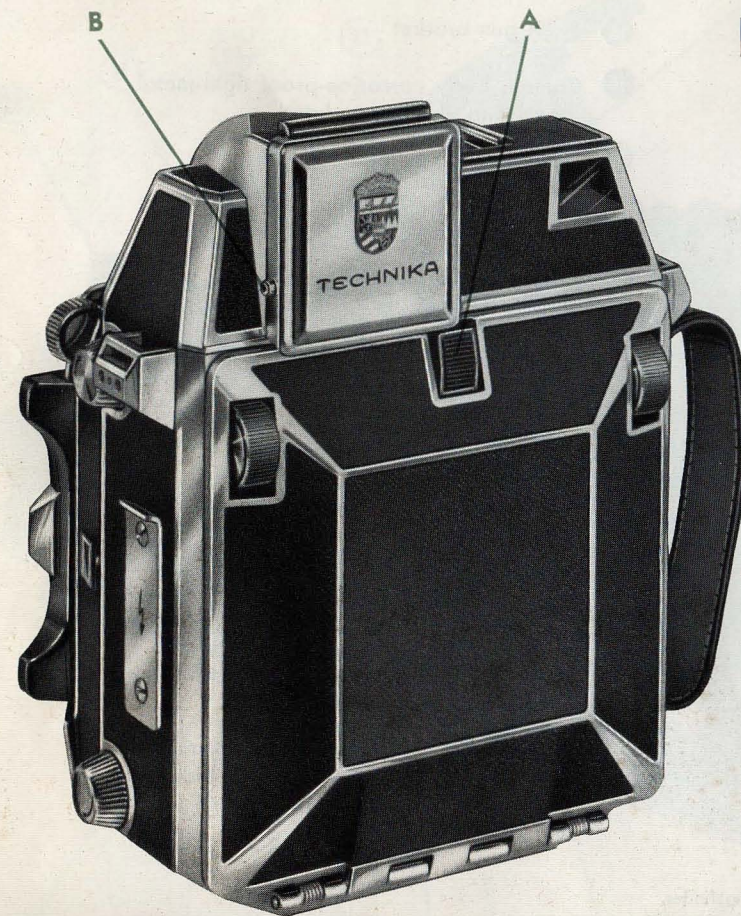
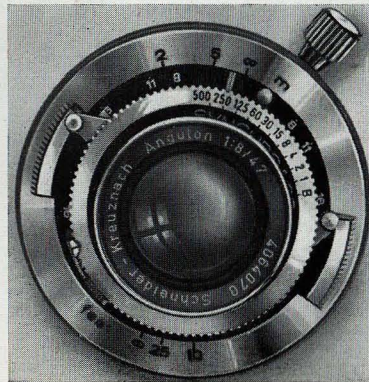

SUPER TECHNIKA 23

Your SUPER TECHNIKA is a precision instrument, designed for outstanding service. Like any optical precision instrument it requires correct handling. In your own interest, please follow the instructions in this manual carefully. Faulty operation may cause jamming. Above all: Never use force. **Get acquainted with every feature of your camera before you put it to actual use.** Once you are familiar with your camera, you will enjoy its ease of handling and smooth operation for many years to come.

TECHNICAL DATA

	Super Technika 2 1/4 x 3 1/4 with Multifocus Rangefinder	Technika 2 1/4 x 3 1/4 without Rangefinder
Height:	7 1/4" (182 mm.)	5 1/2" (142 mm.)
Width:	5 1/4" (135 mm.)	5 1/4" (135 mm.)
Depth:	3 1/2" (90 mm.)	3 1/2" (90 mm.)
Weight (without lens):	64 ozs (1800 grams)	53 ozs (1500 grams)
Bellows Extension:	12" (300 mm.)	
Back:	Revolves 360°; tilts and swings to 10°	
Front:	Standard rises 2" (50 mm.);	
Bed:	drops 15°; tilts back 0-15°	

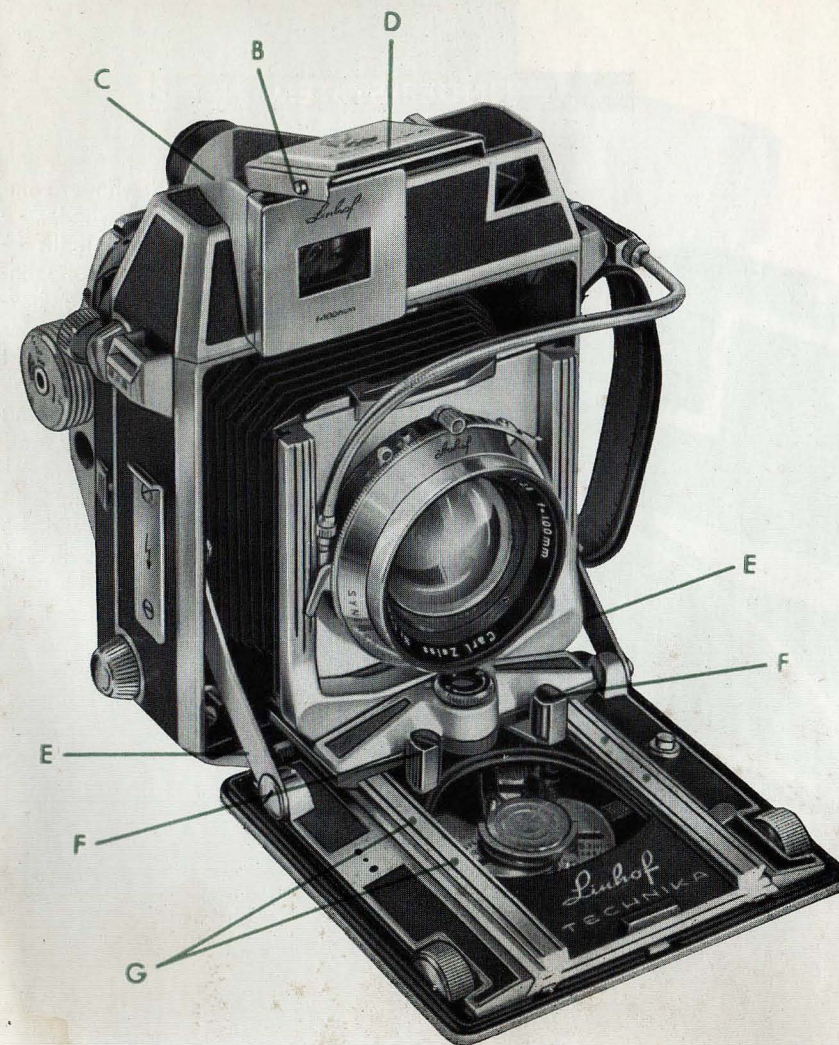

SUPER TECHNIKA 23

The closed camera is well protected against external influences. It can safely be carried by the neck strap. The finder (C) is protected by its cover (D) which also serves as shade when opened.

To open the camera

Push catch (A) downward and let the camera bed down gently until the side struts (E) lock in the first notches. The finder lens cover opens when lightly pressed at side (B). To pull out lens standard, press the two grips (F) and slide the standard onto the track of the camera bed. The track has as many infinity stops (G) as there are lenses coupled with the camera. Pull out the standard until it 'clicks' into the infinity stop for the lens in use.

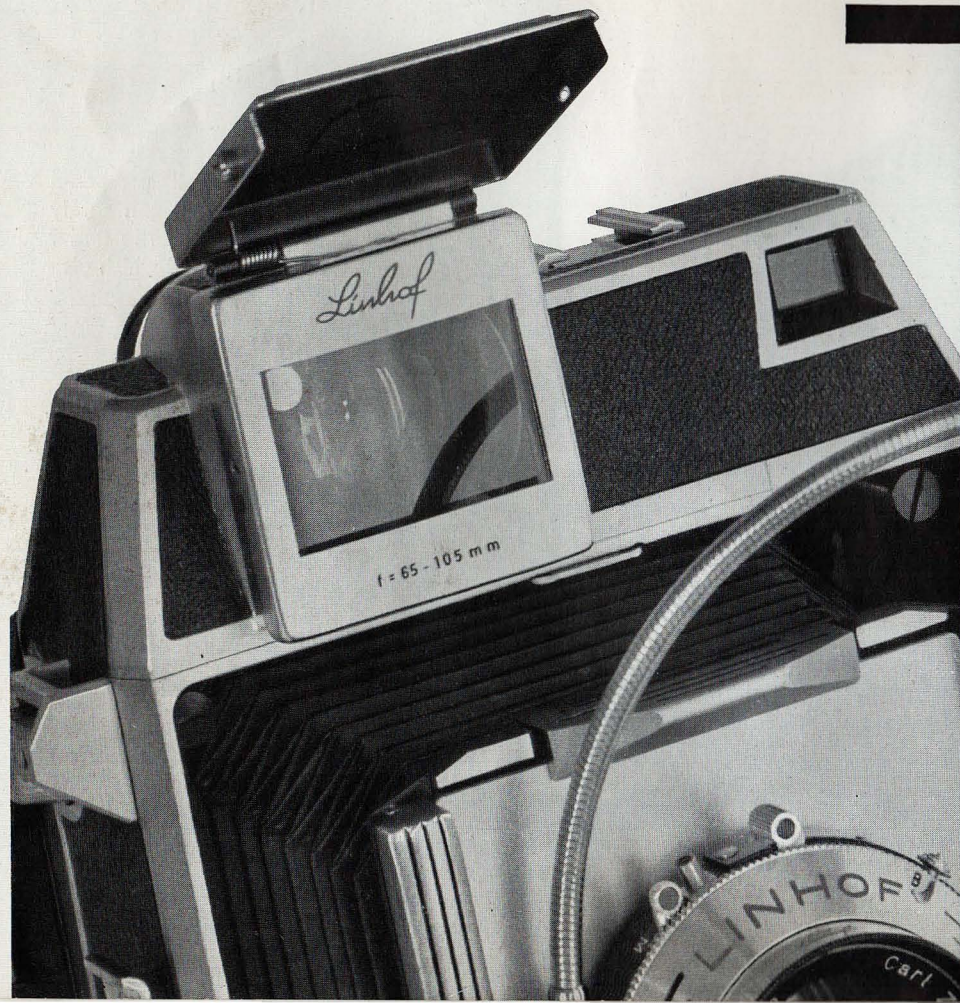

FINDER SYSTEM

The Multifocus range-and-viewfinder combines an optical universal viewfinder — adjustable for different focal lengths — with a critical coincidence-type rangefinder. A rectangle in the center of the viewfinder field shows the bright rangefinder images; when the two images are brought into coincidence to form a single image — by focusing the lens with the focusing knob — the lens is automatically and critically focused. The bright rangefinder image is especially helpful in dim light where groundglass focusing would be difficult. Rangefinder focusing with the normal and wide-angle lens can be used as close as three feet and less from the subject.

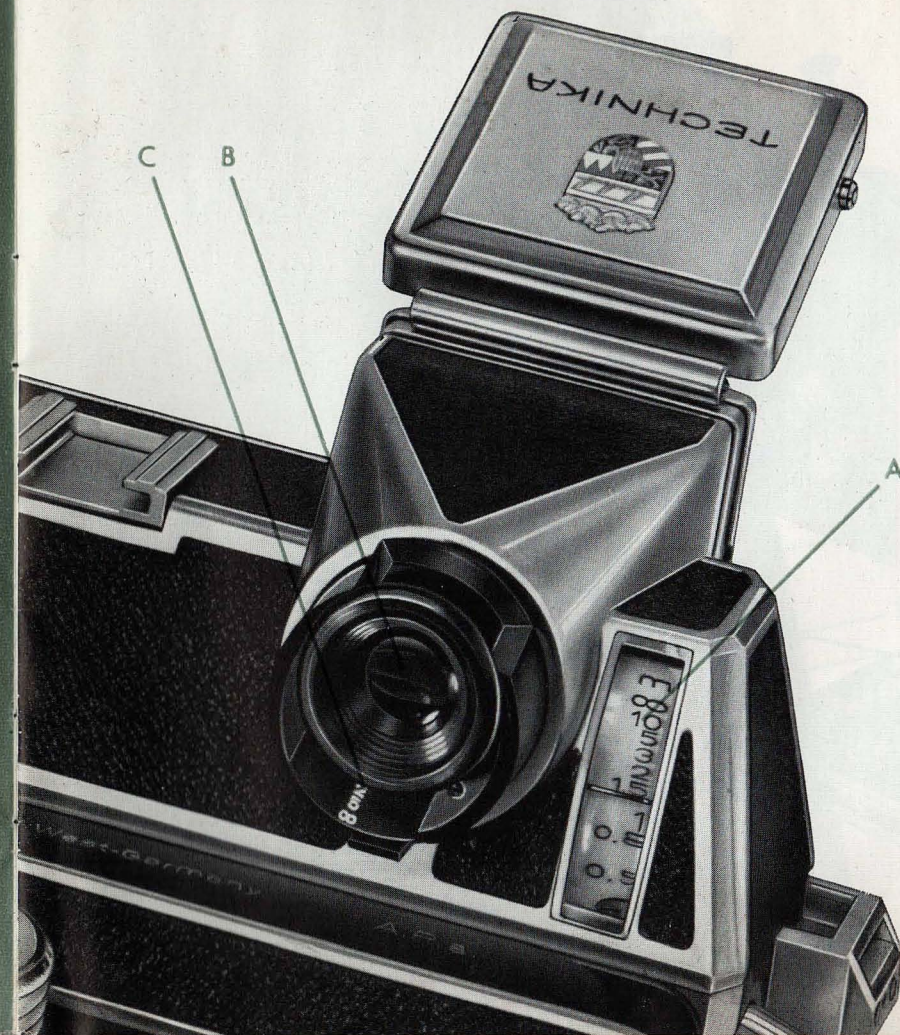

Viewfinder Adjustment for various focal lengths

The field of various lenses is obtained by adjusting the length of the eyepiece tube (B), and by attaching appropriate masks to the viewfinder front lens. Masks can be attached in either horizontal or vertical position to correspond to the position of the camera back.

Wide Angle Lenses. Push eyepiece tube all the way in. For 65 mm. lens use 65-105 mm. mask. For 53 mm. Biogon use special 53 mm. mask.

Normal Lenses: 90 mm. — pull out eyepiece tube to engraved red line; use 65-105 mm. mask; **100 mm.** — pull out eyepiece tube all the way; use 100 mm. mask; **105 mm.** — pull out eyepiece tube all the way; use 65-105 mm. mask;

Telephoto Lenses 180 and 240 mm. — pull out eyepiece tube all the way; use 180 or 240 mm mask. The AUTOMATIC DISTANCE SCALE (A) is actuated by the focusing mechanism and adjusts automatically for another lens when the cam disk is changed.

Parallax Correction. The viewfinder eyepiece (B) can be pushed diagonally upward to the right to correct for parallax; various distances are calibrated beneath the eyepiece (C) for settings from infinity to 3 ft. (1 m.).

LENS COUPLING

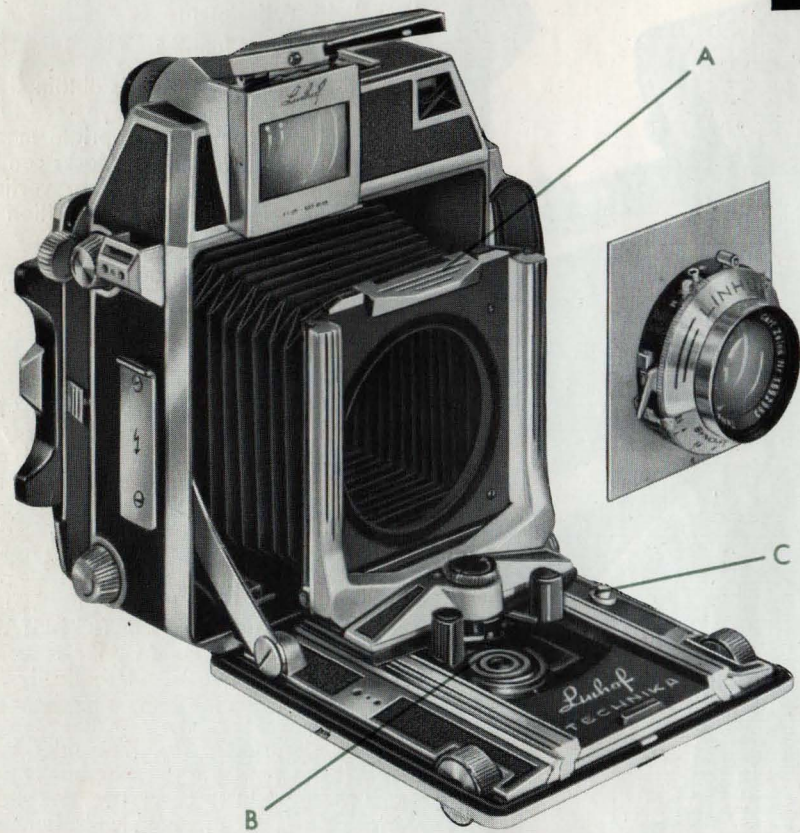

TO CHANGE LENSES, proceed as follows:

1. Push up lock bar (A) and lift out lens and lens board;
2. Push lens standard **all the way** into the camera body so that rangefinder feeler clears cam disk;
3. Raise hinged C-ring of disk locking cap (B); turn counter clockwise (see arrow) two or three turns;
4. Push ejector button (C) to lift cam disk;

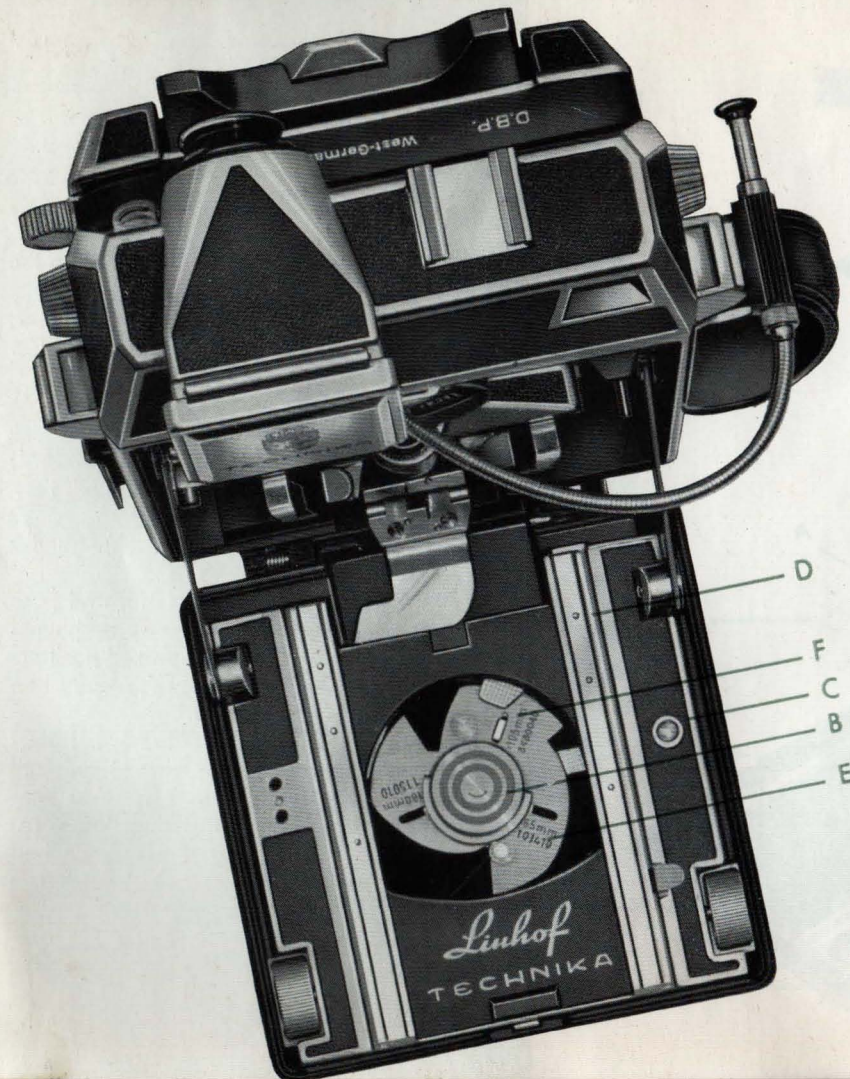

5. Turn disk (E) until the slot marked with the desired focal length and lens serial number engages the key stud. Tighten locking cap (B); fold down C-ring.
6. Pull out lens standard until it clicks into the proper infinity stop (D) on the upper track. Stops and lens markings on the tri-cam disk are color coded for convenient matching;
7. Insert new lens by seating lower edge of its lens board in bottom groove of lens standard; lift lock bar (A) to admit top edge of lens board; BLACK stops and lens markings: Wide-Angle Lens. RED stops and lens markings: Normal Lens. GREEN stops and lens markings: Telephoto Lens. If more than three lenses are coupled to the camera, a second cam disk must be used. Cam disks are readily interchangeable after the locking cap has been loosened and completely pulled off.

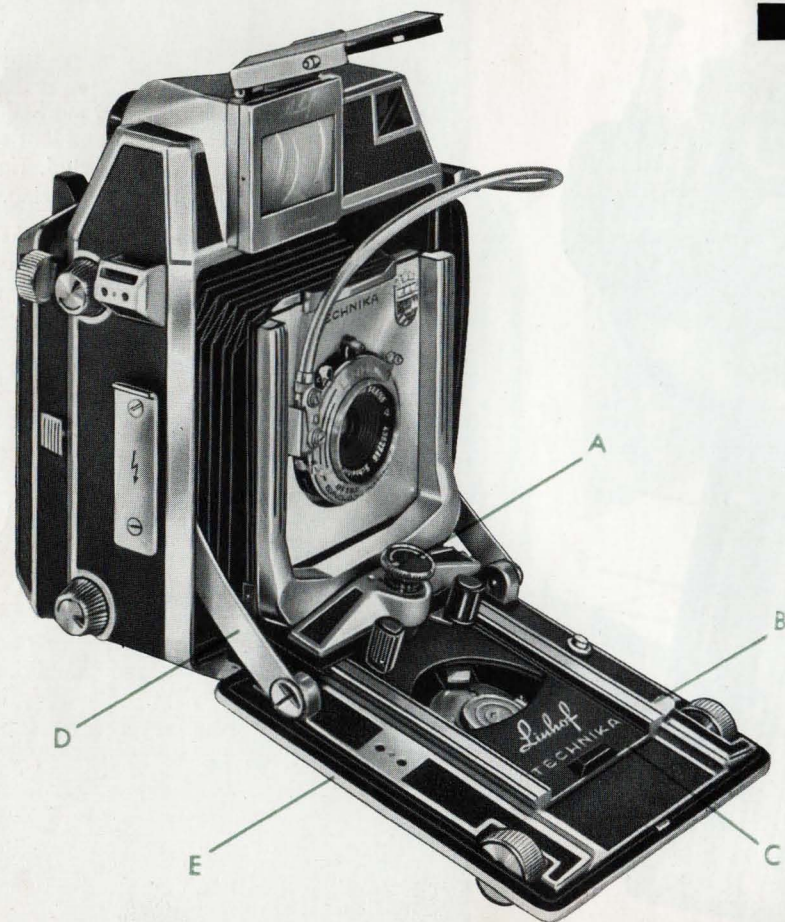

WIDE ANGLE

1. Remove lens from lens standard;
2. Push lens standard all the way into the camera body;
3. Turn cam disk to 53 mm. or 65 mm., respectively (2 and 3 apply only if rangefinder is to be used);
4. Pull out lens standard to wide angle infinity stop (black);
5. Insert wide angle lens in lens standard;
6. Press down on bed struts (D) until they click into second notches;
7. Turn milled tilting knob (A) counter clockwise all the way;
8. Press down track release (B) and push upper track towards camera body until it clicks into a secondary fixed position.

The camera is now ready for operation with the wide angle lens.

To bring the camera back to normal position, first depress track release (B) and pull upper track forward until it clicks into normal position. Turn tilting knob (A) clockwise **all the way**. Press down bed struts and return to first (lower) notches.

TRIPLE EXTENSION

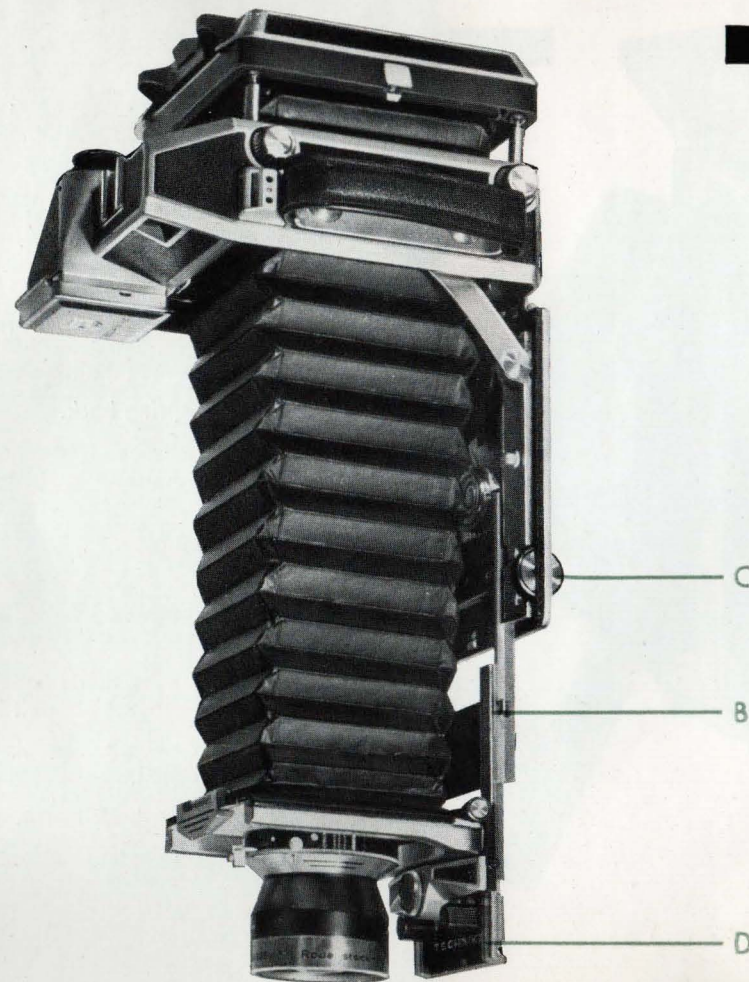

After pressing down track release (B), the upper track (D) can be pulled out to another click stop. By using the focusing knob (C) a total extension of 280 mm. (11 inches) can be utilized; with the swing back pulled out, the extension is increased to 300 mm. (12 inches). Thus, telephoto lenses up to 360 mm. focal length may be used (ground glass focusing only). Also, by using wide angle lenses with triple extension macro-photographs with a reproduction ratio of approximately 3.5:1 may be obtained.

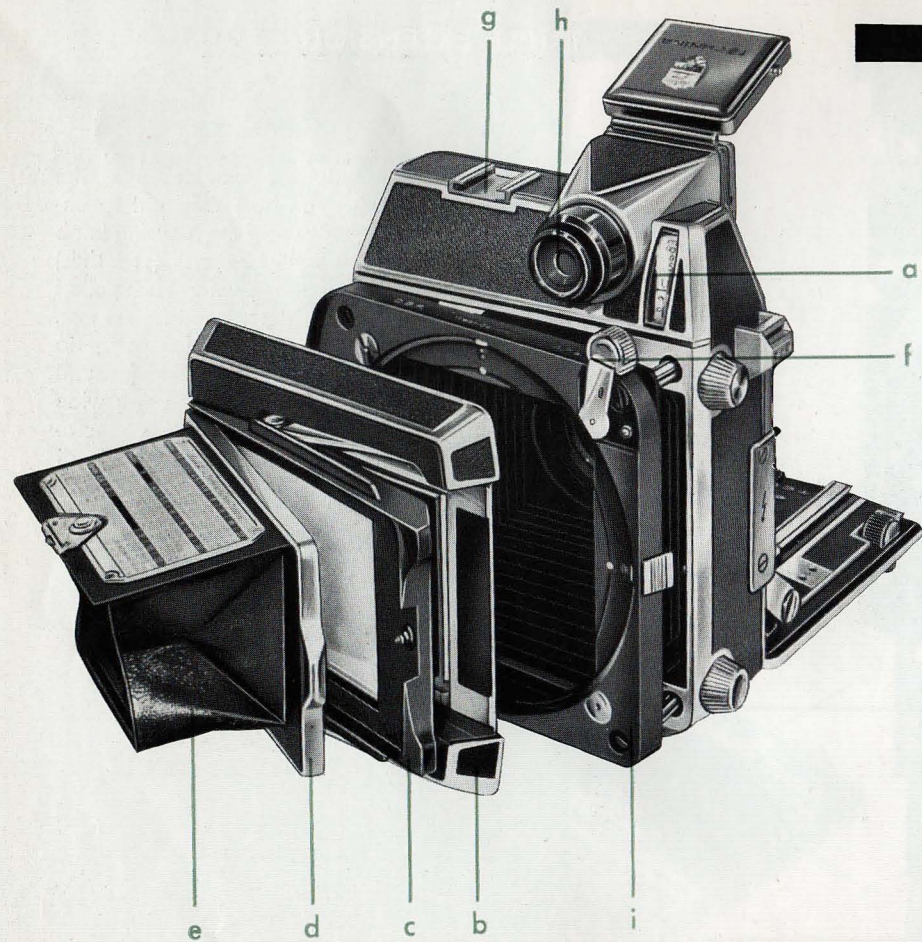

BACK OF CAMERA

- a) Automatic distance scale; operates with all lenses which are coupled to range-finder.
- b) Revolving back with click stops for horizontal or vertical pictures. CAUTION: Before revolving the back, push viewfinder eyepiece tube (h) all the way in.
- c) Groundglass spring back.
- d) Hinged focusing hood frame, permitting use of magnifier for critical groundglass observation.
- e) Focusing hood (open).
- f) Locking lever for interchangeable groundglass back and Rollex roll film holder.
- g) Accessory shoe for sports finder, flash-gun, exposure meter, or spirit level.
- h) Adjustable viewfinder eyepiece with parallax correction.
- i) Adjustable swing back frame.

LINHOF DOUBLE HOLDERS

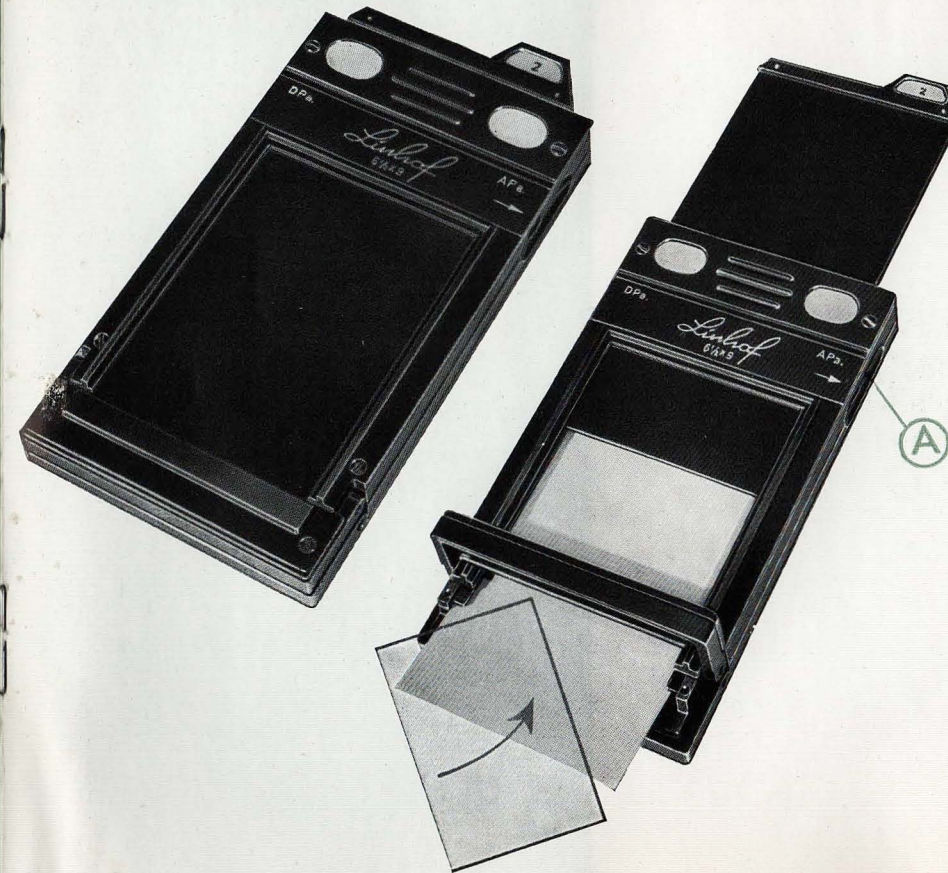

Loading the LINHOF double film / plate holder:

1. Pull up dark slide half way; the spring-tensioned hinged end opens automatically.
2. Insert film or plate; film sheath is not required, see illustration.
3. Hold-down hinged end and insert dark slide all the way.
4. Follow the same procedure for other side of holder.
5. The ejector lever (A) cannot be moved when the holder is loaded. Thus it is easy to check if a holder is loaded or not.

To UN-LOAD: Pull out dark slide about 1 inch to release hinged end; push up ejector lever. Film or plate is pushed out and can readily be withdrawn without danger of touching emulsion side with thumb.

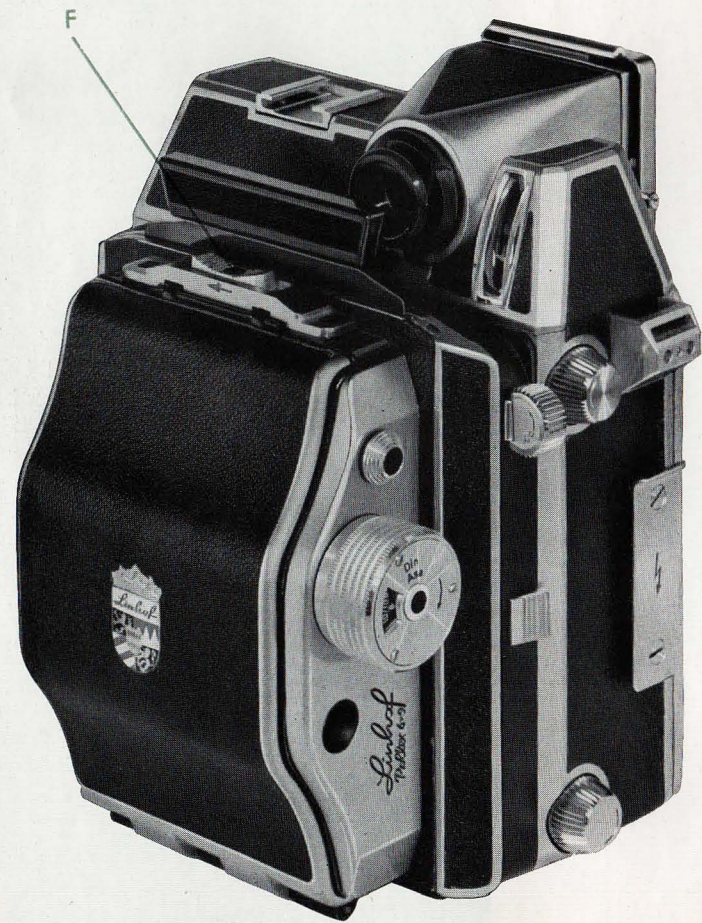

ROLLHOLDER

Loading the ROLLEX 120 Rollfilm Back:

Make sure frame counter window (B) shows "0". If it does not, turn film transport knob (E) clockwise until it stops. Then release button (D) in direction of arrow, wind knob to next stop, release again and repeat until you come to a stop and "0" appears in the window.

With Rollex flat side down, winding knob facing you, open cover by releasing lock (F) in direction of arrow. Lift out film carriage after having pulled film transport knob (E) outward. Insert take-up spool in right compartment and put new film roll in left compartment. Connect paper leader around and under flat side of carriage and over the idler rollers to the take up spool (A), black side outward. Thread leader over the idler rollers to the take up spool. Turn take-up spool in the direction of the arrow marked on side of carriage, until marker (either <—> or < >) appears in the film window of the carriage. The window is located between the center partition and the take-up spool. Now reinsert loaded carriage into the holder by pulling out film transport knob (E) again, and then placing it back into position, so that it engages take-up spool.

At this point the frame counter window still shows "0". Now push film release button (D). With your fingers keep the feed spool from turning and at the same time turn the winding knob (E) slightly to take up the slack. Now close the cover and continue winding. When the first exposure is in place, the film will come to an automatic stop and "1" will appear in the frame counter window (B).

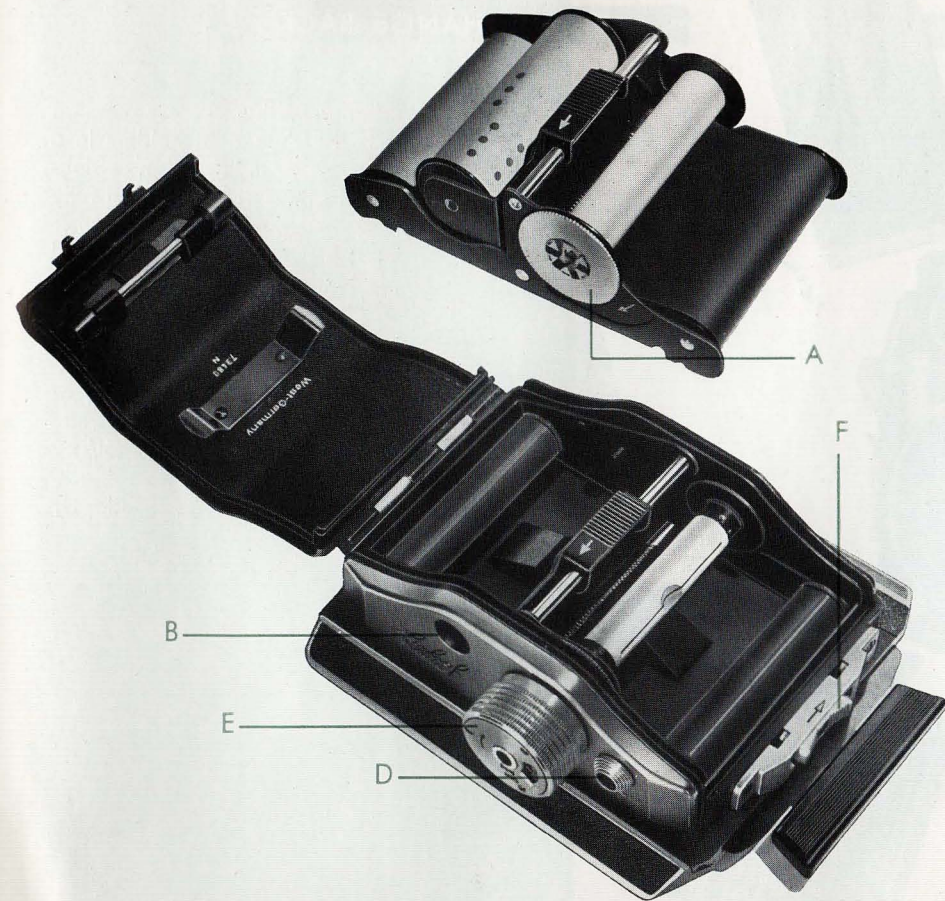

After each exposure push release button (D), let it return and wind film until it stops. After the last exposure, continue winding until "0" appears in the frame counter window (B), at which time the exposed film can be taken out. A film speed reminder is incorporated in the film winding knob (E) and can be set by a downward pressure and turn at its black center.

The Rollex may remain on the camera during loading; the dark slide need not be inserted if the camera shutter remains closed.

The Rollex, like the double cut film/plate holders, can be used in the horizontal or vertical position, and is provided with click stops. For vertical exposures, the slide tab is at the top, covering the viewfinder eyepiece as a reminder that the dark slide must be pulled out before exposure. Similarly, for horizontal exposures, the tab is at the left, preventing use of the camera leather handle; again a reminder to pull out the slide!

The dark slide **MUST** be inserted when the Rollex is detached from the camera.

The automatic film stop of the Rollex permits operation without reference to a film window - an obvious advantage in dim light or complete darkness.

The Rollex is available for use with No. 120/B II rollfilm in two models: 2 1/4 x 3 1/4" (6 x 9 cm.) 8 exposures; 2 1/4 x 2 1/4" (6 x 6 cm.) 12 exposures. A square finder mask is supplied with the 6 x 6 cm. model. For press work and other conditions requiring fast re-loading, a number of pre-loaded film carriage inserts can be held in readiness for instant insertion into the Rollex; inserts are available through your LINHOF dealer.

For convenient interchange from black-and-white to color film, the use of a second or third Rollex will be found very helpful.



QUICK CHANGE BACK

The quick change mechanism of the camera back permits the change of holders in a matter of seconds: A single motion - swinging the lever to the left - unlocks a fully or partly exposed Rollex and another loaded Rollex can be attached, and locked in, instantly; this change may even be made with the camera hand-held to save valuable time. This rapid interchange offers a wide choice of film and film holders: Rollex 2 1/4 x 3 1/4" (6 x 9 cm.) or 2 1/4 x 2 1/4" (6 x 6 cm.), for black-and-white or color; double holders 2 1/4 x 3 1/4" (6 1/2 x 9 cm.) for cut film and plates, also black-and-white or color; film pack adapter 2 1/4 x 3 1/4".

TILTS AND SWINGS

While the swinging and tilting back is normally locked in the focal plane for accurate rangefinder operation, it may be released for use with the ground glass when the use of swings and tilts is desired. Horizontal, vertical, or diagonal movements permit considerable control of perspective, depth of field, distortion, or special effects. Complete information on this subject will be found in the LINHOF TECHNIQUE Data Sheets available through your Linhof dealer or in the new book LINHOF PRACTICE.

To operate swinging back:

Loosen lock knobs (B) on all four corners; press on catch locks (A) while pulling out back (C) which can now be tilted or swung in any direction. When the desired position has been established, the back can be locked in that position by means of the four lock knobs (B), and is ready to receive the film holder for exposure:

NOTE: Always place the camera on a tripod for focusing and taking subjects involving back movements.

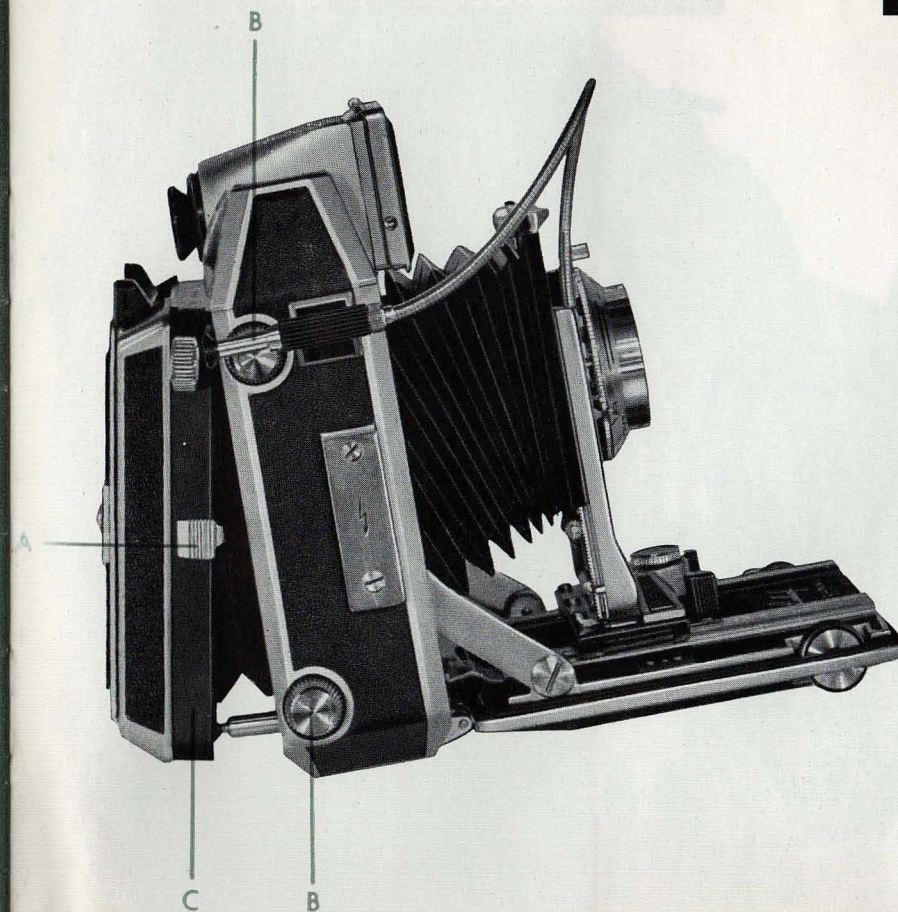

INTERCHANGEABLE LENSES

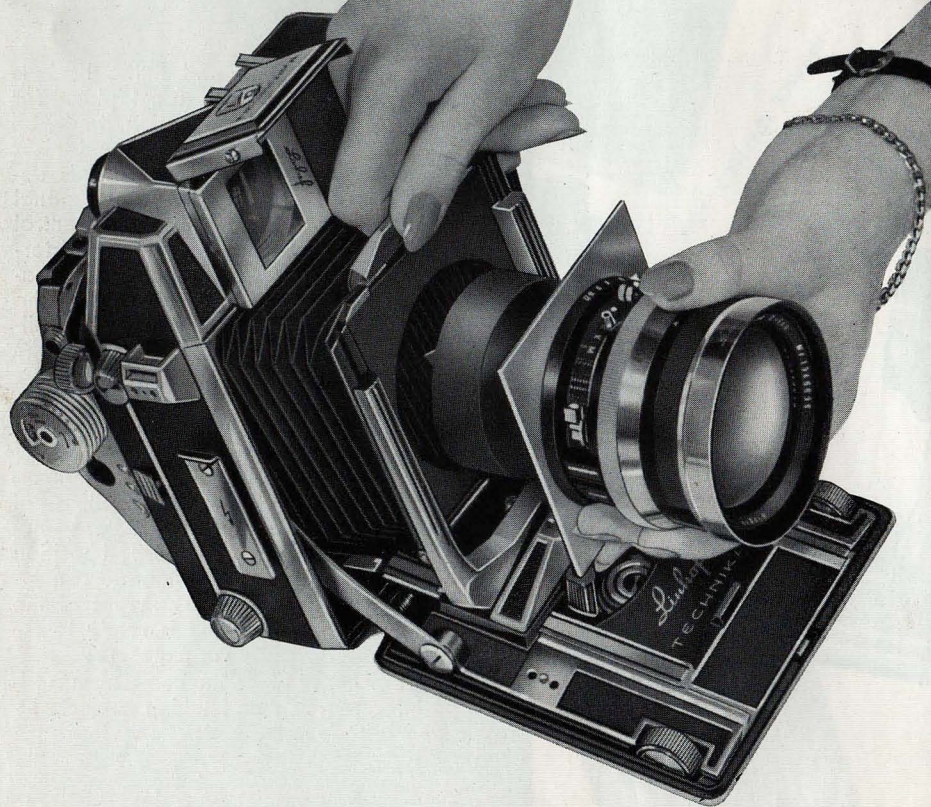

Only the finest lenses are supplied for use with the Super Technika 23. A complete listing of these lenses will be found on the back cover. All lenses are readily interchangeable. However, the extreme wide angle 53 mm. f/4.5 Zeiss Biogon, because of its unusual construction, requires the following special care in handling:

Operating Instructions for the Biogon

- A.** When inserting the Biogon, please proceed as follows:
1. Set cam to proper position for 53 mm. Biogon (operation see page 10).
 2. Pull lens standard half way out on the upper track.
 3. Press down on bed struts until they engage in second notches.
 4. Tilt lens standard all the way back by turning knob.
 5. Raise lens standard 10 mm. (1/2 inch) approximately.
 6. Slip lower edge of lensboard into bottom groove of standard, observing that the flash cable socket is on the upper side.
 7. Lower the raised lens standard to normal position.
 8. Push standard back on the upper track until it clicks into the infinity notch for Biogon (black mark).
 9. Push back upper track with lens standard on it, until it snaps into a secondary stop.

From the same camera standpoint:

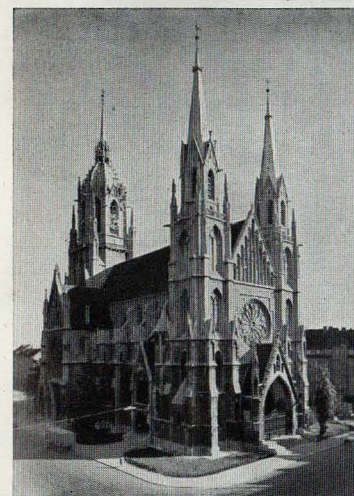

BIOGON
53 mm.

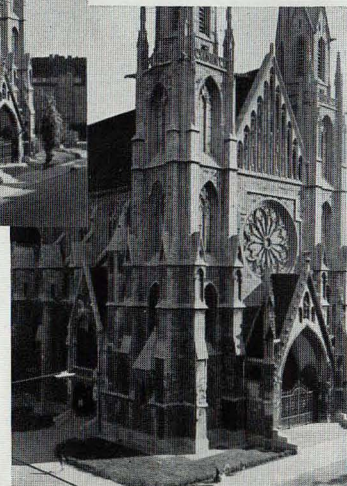

PLANAR
100 mm.



SONNAR
180 mm.

- B.** When taking out the Biogon, the following procedure should be followed:
1. Push down lock and bring upper track back to normal position.
 2. Pull lens standard out half way on upper track.
 3. Raise lens standard 10 mm. (1/2 inch) approximately.
 4. Lift lensboard lock bar and remove lens pushing it gently upward.
 5. Bring tilted lens standard back to normal (vertical) position by turning knob.
 6. Pull upper track forward and press on bed struts to bring camera bed back to normal position.
 7. Again bring the raised lens standard back to normal position.

IMPORTANT: Protect the Biogon with its lens covers when it is out of the camera, particularly the rear element which lies nearly flush with the lens mount. Normal lenses up to 150 mm. and telephoto lenses up to 240 mm. can be coupled to the Multifocus Rangefinder. Longer lenses can be used with groundglass focusing only.

The new Zeiss lenses 53 mm. f/4.5 Biogon, 100 mm. f/2.8 Planar, and 180 mm. f/4.8 Sonnar are especially recommended to the photographer who desires to broaden the scope of his Super Technika 23 outfit.

On the Technika 2 1/4 x 3 1/4" (6 x 9 cm.) without multifocus rangefinder, longer lenses up to 360 mm. (14 1/4") may be used for scale or groundglass focusing. The 360 mm. Tele-Xenar may be focused as close as 12 feet (3.5 m.) by scale, and 5 feet (1.5 m.) by groundglass. Lenses already owned by the photographer may also be installed on the Super Technika or Technika camera.



FLASH GUN, ANATOMICAL GRIP

In conjunction with the SUPER TECHNIKA $2\frac{1}{4} \times 3\frac{1}{4}$ ", any type of electronic or regular flash unit may be used. The MX-synchronized shutters allow a perfect synchronization of the flash gun, whereby with electronic flash units the selector lever is set on X. When using bulbs, the selector lever is set on X for speeds up to $\frac{1}{25}$ and set on M for shutter speeds over $\frac{1}{25}$ sec.

Flash photography is not only limited to darkness, it is likewise of great advantage on backlighted objects and particularly in colour photography in order to obtain more shadow detail. For guide numbers and general use of flash units please refer to operating instructions and data supplied with them.

A good hold on the camera is assured by the anatomical grip shown in the adjoining illustration; this grip, molded to conform to the shape of the hand, has a built-in removable cable release, and may be installed in place of the leather camera handle. It permits convenient one-hand operation of the camera. For special applications a right-hand grip may be mounted on the camera's flash bracket.

The hand grip is available for Super Technika and Technika $2\frac{1}{4} \times 3\frac{1}{4}$ ", 4×5 ", and 5×7 " and may also be mounted on older models of these cameras. Its hand-fitting, practical design will be found of great value to the photographer who wants utmost steadiness in hand-held shots.

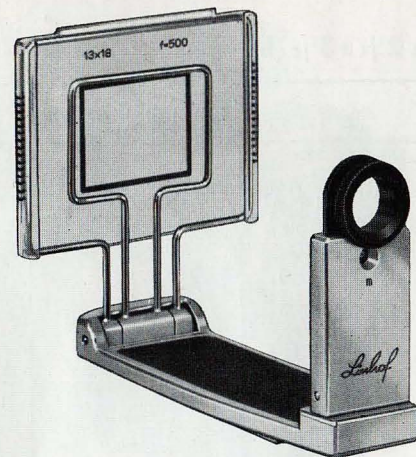

SPORTS FINDER

The LINHOF Sports Finder, specifically designed for sports, action and press photography, is attached to the SUPER TECHNIKA 23 by means of the accessory clip. The camera back must be turned in horizontal position, because the Sports Finder only indicates a horizontal composition. Whenever a vertical composition is desired, turn the whole camera 90° to the right, hand-strap or Anatomical Grip with shutter release on top, while the right hand supports the camera.

The Sports Finder has two frames, the outer one being used for normal lenses from 90 to 105 mm, the inner one for tele lenses of 180 mm focal length.

Slip-on Plexiglass Masks with appropriate delineation are available for the $2\frac{1}{4} \times 2\frac{1}{4}$ " (6×6 cm) Rollex or for other focal length lenses, except wide angle (see table at left).

The peep sight of the Sports Finder is provided with a parallax slide to 9 ft. (3 meters).

Focal Length mm	Negative Format		
	$2\frac{1}{4} \times 2\frac{1}{4}$ "	$2\frac{1}{4} \times 3\frac{1}{4}$ "	6×9 cm
90—105	48.5 x 48.5	N	N
120	42.5 x 42.5	38.4 x 57.6	42.3 x 65.2
127—135	37.8 x 37.8	34.2 x 51.2	37.5 x 58
150	32.8 x 32.8	29.6 x 44.5	32.6 x 50.5
180	27.4 x 27.4	T	T
240	19.5 x 19.5	17.6 x 26.4	20.2 x 27.8
270	16.5 x 16.5	15.1 x 22.6	17.2 x 23.8
360	11.3 x 11.3	10.2 x 15.4	11.7 x 16.2

Note: a) All dimensions are in mm (size of delineation).

b) N = large frame for normal lenses.

c) T = small frame for tele lenses.

Lenses for the Super TECHNIKA 2¹/₄ x 3¹/₄ (6 x 9cm)

Lens	Focal Length	Lens Speed	Front Diameter	Shutter	Fastest Shutter Speed	
Wide Angle Lenses						All shutters have full M-X flash synchronization. Compur Shutters size 0 and 1 have press stop (blade arrester). Compur Shutters size 1 have additional T-setting and built-in self-timer. Compur Shutters size 00 have no press stop and no T-setting. In order to keep the shutter open for ground glass viewing or time exposures use cable release with time lock.
Technika-Biogon	53 mm	4.5	70 mm	Compur 0	1/500	
Technika Angulon	65 mm	6.8	32 mm	Compur 00	1/500	
Technika Angulon **) . .	90 mm	6.8	42 mm	Compur 0	1/500	
Technika Super Angulon	47 mm	8	42 mm	Compur 00	1/500	
Technika Super Angulon **)	65 mm	8	51 mm	Compur 00	1/500	
Technika Super Angulon **)	90 mm	8	70 mm	Compur 00	1/500	
Normal Lenses						
Technika Planar	100 mm	2.8	60 mm	Compur 1	1/400	
Technika Tessar	105 mm	3.5	42 mm	Compur 0	1/500	
Technika Xenar	105 mm	3.5	42 mm	Compur 0	1/500	
Technika Xenotar	105 mm	2.8	51 mm	Compur 1	1/400	
Technika Apo-Lanthar . .	105 mm	4.5	42 mm	Compur 0	1/500	
Technika-Symmar **) . .	105 mm	5.6	32 mm	Compur 00	1/500	
Telephoto Lenses *)						
Technika Sonnar	180 mm	4.8	60 mm	Compur 1	1/400	
Technika Tele-Arton . . .	180 mm	5.5	42 mm	Compur 0	1/500	
Technika Tele Xenar . . .	180 mm	5.5	42 mm	Compur 0	1/500	
Technika Telomar	180 mm	5.5	42 mm	Compur 0	1/500	
Technika Rotelar	180 mm	4.5	51 mm	Compur 0	1/500	
Technika Tele-Arton . . .	240 mm	5.5	51 mm	Compur 1	1/400	
Technika Telomar	240 mm	5.5	51 mm	Compur 1	1/400	

*) All lenses listed above can be coupled to the Multifocus Rangefinder. Longer telephoto lenses can be used only for groundglass focusing.

**) Lenses particularly recommended for camera movements.